

Operating instructions

hawos Easy



*Congratulations
on purchasing
your hawos flour mill!*



hawos.

⚠ ATTENTION:

Safety is paramount!

- ⚠ Only connect your mill to a properly installed socket with earthing contact.
- ⚠ Do not use defective units.
- ⚠ If the mains cord is damaged, only the manufacturer, its customer service department or a qualified professional may replace it.
- ⚠ Only authorised hawos professionals may perform repairs.
- ⚠ Never operate your mill unattended!
- ⚠ Never reach into the funnel or flour outlet when the unit is operating – risk of injury!
- ⚠ Before opening the housing, be absolutely sure to pull the mains plug to prevent the unit from accidentally activating – risk of injury!
- ⚠ This device is not intended for use by persons (including children) with impaired physical, sensory or mental abilities or who lack

experience and/or knowledge unless they are supervised by a person responsible for their safety or have been instructed by such a person in how to use the device. Children must be under supervision to ensure that they do not play with the device.

- ⚠ Never immerse the device in water.

hawos flour mills are equipped with an overcurrent circuit breaker that protects the motor from excessive current consumption (e. g. if debris jams the grindstones).

In addition to the afore mentioned overload safety switch, the motor is also equipped with a overheating protection, which deactivates the mill in the event of an overload. If this occurs, set the On/Off switch to "Off". Once your hawos mill has cooled off, you can use it again.

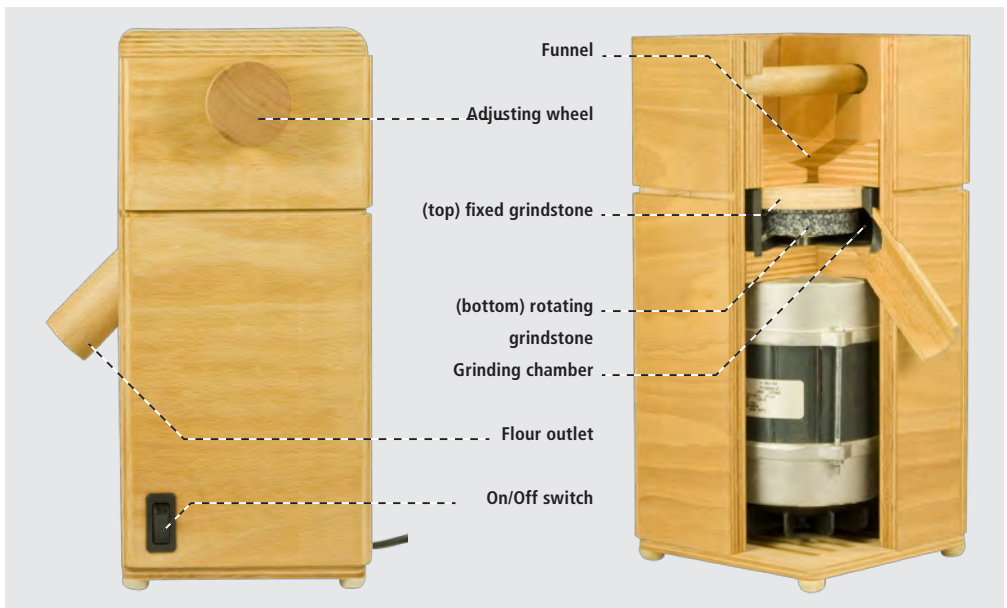

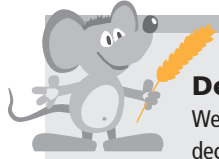

Dear mill owner,

We are delighted that you have decided on the flour mill from hawos!

Your hawos will serve you well in preparing your natural food cuisine for many years to come. Please observe the following notes before using it for the first time. Please carefully read through these operating instructions to familiarise yourself with your hawos. It will reward you with reliability and convenience.

Proper use

The mill is conceived and designed for private household use. The device is intended for grinding the foods listed on page 5.

Product contents

Mill, funnel lid

Brief instructions

- Connect to a properly installed socket with earthing contact
- Place the flour bowl under the flour outlet
- Set the fineness with the adjusting wheel
- Add the flour to the funnel
- Turn the device on, correct the fineness as needed
- After milling, turn the device off
- Only use the flour mill for grinding food! A table of edible mill feed is provided on page 5.

Before first use

Before you use the device for the first time, please first carefully read through the safety instructions and operating instructions. Only in this way will you be able to use all functions safely and reliably. Hold onto these operating instructions for future reference. Pass these operating instructions on to any subsequent user of the product.

1. Mill feed

Please only use clean and dry grains. You can determine this if the seed crackles distinctly when you crush it against a hard surface with a spoon. Wet grain can be crushed and then looks like an oat flake. Consult the list "Suitable mill feed" on page 5 when adjusting the fineness. Please only mill sweet corn for grinding corn.

Only process mill feed with the device once.

2. Power supply

Only connect the mill to an alternating current source. Check whether the existing mains voltage corresponds to the voltage specified on the base plate.

3. Location

The mill housing is made of wood. Wood is a living material that is affected by changes in temperature and humidity, which may cause it to crack. You can best protect and care for the housing by not placing the mill close to radiators and not placing it right next to a stove (steam, moisture).

4. Setting up the mill

⚠ During use, place the flour mill on a hard, level base (kitchen countertop). The slots on the bottom of the device may not be obstructed so that the motor can be ventilated.

Start-up

Please first read the section
**"Before first use" (P. 3) and the
 safety notes (P. 2)!**

Milling

Once connected to a power supply, your hawos mill is ready for use.

Place a bowl under the flour outlet and adjust the fineness as desired (figures 1-3). Then fill the funnel with grain and turn on the mill.



Figure 1: Turn the adjusting wheel to set the fineness.

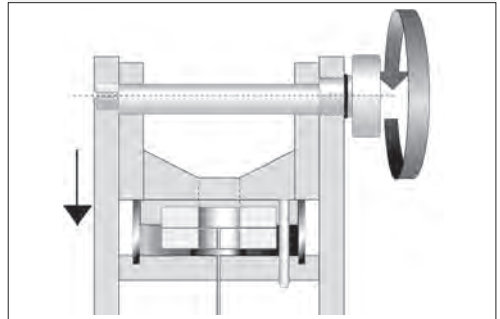
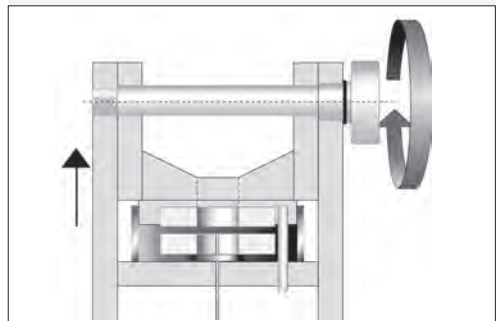

Figure 2 + 3: Turning the adjusting wheel will lift and lower the funnel insert.



Setting the fineness

You can steplessly set the fineness of the mill feed from coarse to fine with the adjusting wheel.

(When you turn the wheel towards "fine", the funnel insert will lower). When changing the setting from coarse to fine the mill should either

- be on
- or the grinder must be empty.

The different types of grain and other mill feed differ considerably with respect to their fat and fibre content, endosperms etc. Our table "Suitable mill

feed" is based on this. hawos mills have undergone extensive testing and this table was compiled accordingly for your reference.

The finer you grind, the more probable clogging of the grindstones becomes. Pay attention to the milling noise: If it diminishes considerably, then the grindstones are starting to clog. Set the adjusting wheel to coarser.

Turn off the mill once all mill feed has been processed.

Suitable mill feed

Wheat
Rye
Spelt
Barley
Oats
Millet
Sweet corn
Durum wheat
Brown rice (not parboiled rice)
Buckwheat
Green spelt
Flax seed (mix 1:1 with wheat)
Chick peas
Green peas
Nutritional yeast
Quinoa
Amaranth

Feel free to also try foods that can be rolled and those that can be poured that are not indicated on the adjacent table, e. g. dry spices. Proceed with care when trying new types and let us know about your results: We are always delighted to learn more. Oilseeds jam the grinder due to their high fat content. For this reason, mix mill feed with high fat content 1:1 with wheat or another grain.

Cleaning

A brush is integrated in the bottom rotating grindstone of your hawos, which sweeps out the flour with every rotation, thereby automatically cleaning the mill.

If you don't intend to use your mill for a prolonged period of time, we recommend cleaning any leftover flour out of the grinder. This is very easy with a vacuum cleaner. Set the adjusting wheel to "coarse" and then insert the vacuum cleaner nozzle into the funnel and flour outlet of the mill when it is activated.

Do not in any case clean the housing with abrasive cleaners. Never immerse the unit in water! If necessary, clean the housing with a damp cloth and then rub in a small amount of vegetable oil to preserve the surface.

Faults

In the unlikely event of a fault, you can rectify it easily:

The motor doesn't start: Is the mill connected to a power supply? Has the plug been properly connected with a socket? Is the funnel inserted properly (microswitch)?

Solution:

- Check and rectify any defect

The motor hums, but doesn't start running:

When turning off the unit, grain may have clogged between the grindstones and may have jammed them.

Solution:

- Turn the adjusting wheel to "coarse" with the motor turned on until the milling process starts again
- Slowly turn the wheel back to "fine" (page 4, figures 1–3)

The mill is on, but no flour is emitted:

If the grain is too wet or e. g. if spelt and oats are ground too finely, the grindstones may be "smeared".

Solution:

- Mill approximately 100 g brown rice (semi-coarse setting)
- If necessary, open the grinder and remove any leftovers (see the section "Opening the grinder" for this)

The mill turns off while in use: Debris or clogged grindstones may cause the mill come to a standstill. In such a case, the overcurrent circuit breaker automatically deactivates the mill after approximately 20 seconds.

Solution:

- Remove any debris and/or after the mill has cooled off, mill approximately 100 g brown rice (semi-coarse setting)

The adjusting wheel cannot be turned to the "fine" setting:

If an overfilled flour bowl causes e. g. the flour to back up, this may jam the grinder. There is leftover grain or debris in the grinder.

Solution:

- When the mill is running, turn to the adjusting wheel to the "coarse" setting and allow the grinder to run without any mill feed
- If necessary open the grinder and remove any leftover flour and/or debris. If the grindstones are heavily laden, clean them with a dry, hard brush (for this, see the section "Opening the grinder")

The flour fineness setting changes by itself:

The adjusting wheel setting changes while in use.

Solution:

- Tighten the brake screw on the side opposite the adjusting wheel so that the wheel bracket can be adjusted easily, but the setting does not change by itself. The rubber ring may only press up against itself slightly (figure 7)

Figure 4
With a screwdriver, remove the brake screw on the housing side opposite the adjusting wheel.



Figure 5
Pull the adjusting wheel together with its axle out of the side.



Figure 6
Remove the funnel insert.



Figure 7
Screw the brake screw back in, adjust the play of the adjusting wheel.



Opening the grinder



⚠ Attention! Turn off the mill with the On/Off switch and then disconnect the mains plug before opening the housing to prevent the device from accidentally turning on – risk of injury! A microswitch will prevent the device from accidentally activating if the funnel insert is not in place.

- Unscrew the brake screw on the side opposite the adjusting wheel (figure 4)
- By means of gently turning the adjusting wheel, remove it together with the axle (figure 5)
- Take out the funnel insert (figure 6)

In order to subsequently reassemble the mill, reverse the steps:

- Install the filter insert
- Insert the adjusting wheel axle through the side opening
- Screw in the brake screw on the other side. Adjust the play of the adjusting wheel with the brake screw, the rubber ring may only press up against itself slightly (figure 7)

Technical data

Model	Easy
Housing	Beech Multiplex
Funnel fill volume	560 g (wheat)
Base dimensions L x W (mm) Height (mm)	150 x 150 330
Grinding capacity for wheat	Approximately 100 g/min
Mill	Corundum ceramic grindstone, horizontally positioned, Ø 70 mm
Weight	7,9 kg
Motor output	360 watts/230 volts, 50 Hz
Warranty	10 years The mill is conceived and designed for private household use. The device is intended for grinding the mill feed listed on page 5. Any other use is deemed improper. hawos assumes no liability for cases of improper use.
 	At the end of its lifecycle, this product must be turned in at a collection point for recycling electric and electronic appliances. The materials can be reused as labelled. Please contact your community or city administration for the respective collection point.

hawos Service

If you have questions about your mill, please give us a call or write us an e-mail, our customer service team is happy to assist you. Tel.: +49 (0) 6172 401200 • E-mail: info@hawos.de

hawos.

Strong Mills – Fine Flour

hawos Kornmühlen GmbH
Massenheimer Weg 25
D-61352 Bad Homburg v.d.H.
Germany
Tel.: +49 (0) 6172 40120-0
Fax: +49 (0) 6172 40120-19
info@hawos.de · www.hawos.de